

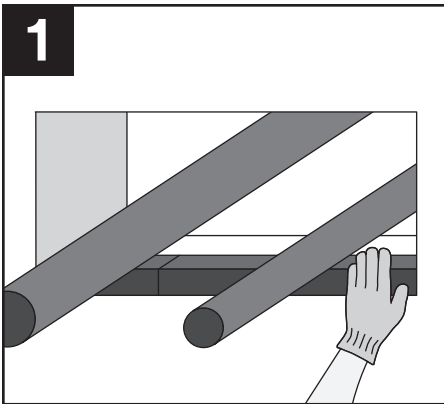

## 3M™ Fire Barrier Block B258 3M™ Fire Barrier Plank PK39

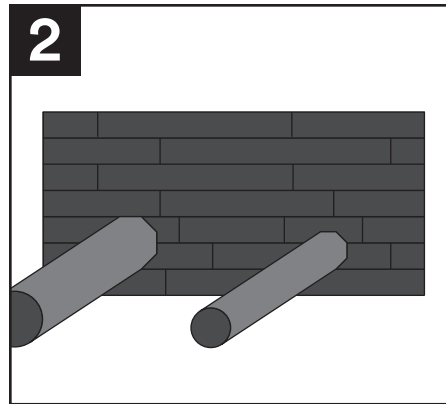

Install 3M™ Fire Barrier Blocks/Planks with the 5 in. (130mm) dimension projecting through the floor or wall and centered within the opening. Blocks/planks should be installed so the integrated grid is not in contact with the substrate or in a grid-to-grid manner.



Continue to install blocks/planks until through opening is completely full and blocks/planks are firmly packed together. Block/plank can be resized in the field as needed provided the 5 in. (130mm) dimension is maintained through the opening. No compression is necessary.

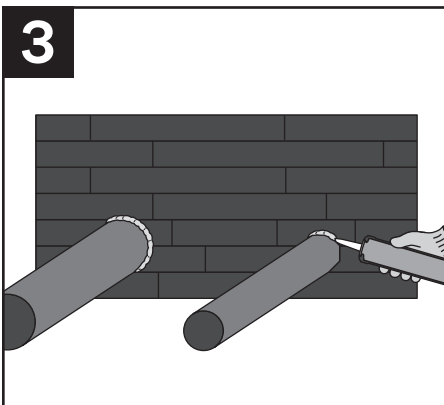

Install 3M™ Fire Barrier Rated Foam FIP 1-Step between the blocks/planks and the periphery of the opening and between blocks/planks and penetrants. Foam to be installed full depth of the blocks/planks. Check for any openings between blocks/planks, framing and penetrating items. Fill any visible openings with the required depth of foam.

Additional firestop may be necessary for non-metallic penetrants. Consult individual UL systems for foam depth and location requirements.

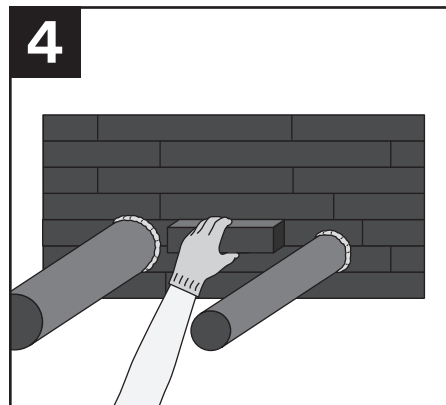

To remove the blocks/planks, gently pull them out and place on a clean surface. After penetrants are routed through or removed from the opening, replace the blocks/planks, making sure that they are firmly packed and fully filling the opening. Install foam in any voids as required.

# 3M™ Fire Barrier Plug PLG2

# 3M™ Fire Barrier Plug PLG4

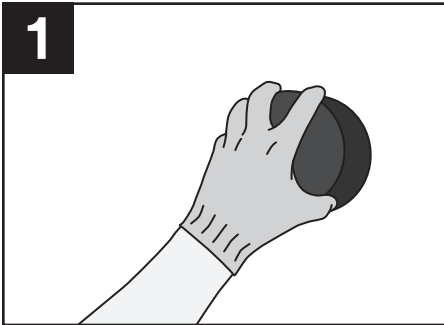

1  
Install 3M™ Fire Barrier Plug within the opening, flush with top surface of floor or both sides of wall. To fit smaller openings, plugs may be compressed to size or a wedge may be cut from plug to reduce size.

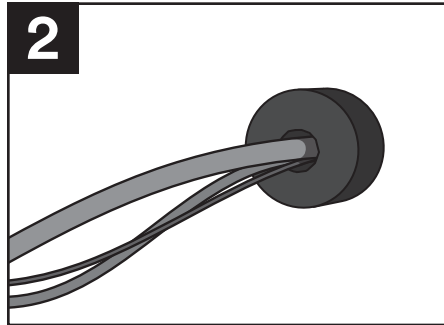

2  
Plugs may be cut to fit around cable penetrants.

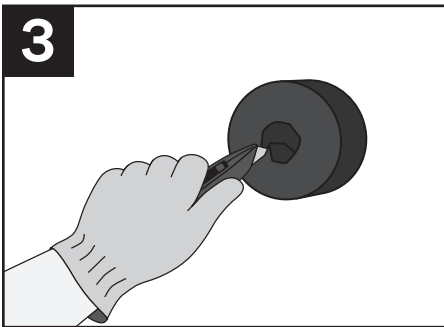

3  
Holes may be cut/punched through plugs to route cables directly through.

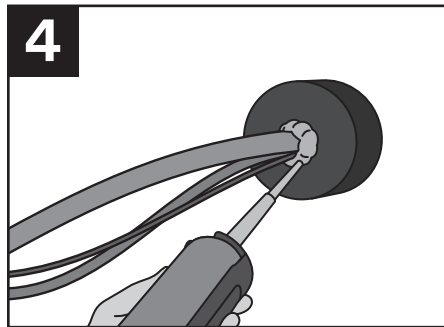

4  
Fill all voids and interstices of cables with 3M™ Fire Barrier Rated Foam FIP 1-Step, full depth of the plug.

## Installation Guide

This installation guide highlights requirements for 3M™ Fire Barrier Block B258, 3M™ Fire Barrier Plank PK39, 3M™ Fire Barrier Plug PLG2 and 3M™ Fire Barrier Plug PLG4 for firestopping general through-penetration applications. This guide is intended only to highlight general steps or methods and is not intended to describe all details and requirements. System specifications should comply with local and federal regulations. Examples of system specifiers include UL, Intertek, and European Technical Approvals and Assessments. Installer should confirm that the field conditions (such as opening size, pipe size and material, insulation type and thickness, and annular space) comply with the system specifications.

## Repair Procedure in Case of Damage

Damaged seals shall be removed and replaced.

## Precautionary Information

Refer to product label and Safety Data Sheet for health and safety information before using the product. For information please contact your local 3M Office.  
[www.3M.com/SDS](http://www.3M.com/SDS)



3M Industrial Adhesives and Tapes Division  
3M Center, Building 225-3S-06  
St. Paul, MN 55144-1000

Phone 800-328-1687  
Web [3M.com/firestop](http://3M.com/firestop)

### Important Notice to User:

**Technical Information:** The technical information, recommendations and other statements contained in this document are based upon tests or experience that 3M believes are reliable, but the accuracy or completeness of such information is not guaranteed. **Product Use:** Many factors beyond 3M's control and uniquely within user's knowledge and control can affect the use and performance of a 3M product in a particular application. Given the variety of factors that can affect the use and performance of a 3M product, user is solely responsible for evaluating the 3M product and determining whether it is fit for a particular purpose and suitable for user's method of application. **Warranty and Limited Remedy:** 3M warrants that each 3M Fire Protection Product will be free from defects in material and manufacture for 90 days from the date of purchase from 3M's authorized distributor. 3M MAKES NO OTHER EXPRESS OR IMPLIED WARRANTIES, INCLUDING ANY IMPLIED WARRANTY OF MERCHANTABILITY OR FITNESS FOR A PARTICULAR PURPOSE. If a 3M product does not conform to this warranty, the sole and exclusive remedy is, at 3M's option, replacement of the 3M product or refund of the purchase price. **Limitation of Liability:** Except where prohibited by law, 3M will not be liable for any loss or damage arising from the 3M product, whether direct, indirect, special, incidental or consequential, regardless of the legal theory asserted.

3M is a trademark of 3M Company. © 3M 2016. All rights reserved.