

Dynabrade Nitro Series™

2" Right Angle Disc Sander

Safety, Operation and Maintenance – Save This Document and Educate All Personnel

Model	Diameter	RPM	Pad Type	Spindle Thread
DS32	2"	18,000	Locking Type (Female)	1/4" – 20







SANDER/POLISHER



Find The Most Current Offering of Support Documents and Accessories at www.Dynabrade.com

⚠ WARNING

Read and understand this tool manual before operating your air tool. Follow all safety rules for the protection of operating personnel as well as adjacent areas. Always operate, inspect and maintain this tool in accordance with the American National Standards Institute (ANSI). Safety Requirements for abrading materials with coated abrasive systems – ANSI B7.1, Compressed Air and Gas Institute (CAGI) Safety Code for Portable Air Tools – B186.1, Code of Federal Regulation – CFR 29 Part 1910, International Organization for Standardization (ISO) Hand Held Non-Electric Power Tools – Safety Requirements and applicable State and Local Regulations.

-  Read and understand tool manual before work starts to reduce risk of injury to operator, visitors, and tool.
-  Eye protection must be worn at all times, eye protection to conform to ANSI Z87.1.
-  Ear protection to be worn when exposure to sound, exceeds the limits of applicable Federal, State or local statutes, ordinances and/or regulations.
-  Respiratory protection to be used when exposed to contaminants that exceed the applicable threshold limit values required by law.
-  Practice safety requirements. Work alert, have proper attire, and do not operate tools under the influence of alcohol or drugs.
-  Air line hazard, pressurized supply lines and flexible hoses can cause serious injury. Do not use damaged, frayed or deteriorated air hoses and fittings.

Some dust created by sanding, grinding, drilling, and other construction activities contain chemicals known to cause cancer, birth defects or other reproductive harm. Some examples of these chemicals are:

- Lead from lead-based paints
- Crystalline silica from bricks and cement and other masonry products
- Arsenic and chromium from chemically treated lumber

Your risk from these exposures varies, depending on how often you do this type of work. To reduce your exposure to these chemicals: work in a well ventilated area, and work with approved safety equipment, such as those dust masks that are specially designed to filter out microscopic particles.

SAFETY and OPERATING INSTRUCTIONS

-  Carefully Read and Understand the General and Sander/Polisher sections found in Tool Safety and Operating Guidelines (PN00001676) Before Handling or Using Tool.
- Carefully Read all instructions before operating or servicing any Dynabrade® Abrasive Power Tool. Products offered by Dynabrade are not to be modified, converted or otherwise altered from the original design.

Tool Intent: Dynabrade Nitro Series™ 2" Diameter Disc Sanders are ideal for material removal and finishing using 2" Backup pads with appropriate sized abrasives.

DO NOT USE Tool for Anything Other Than Its Intended Applications.
Training: Proper care, maintenance, and storage of your air tool will maximize tools performance and reduce chance for accident.
Employer's Responsibility: Provide operators with safety instructions and training for safe use of tools and accessories.
Report to Your Supervisor any Condition of the Tool, Accessories or Operation you Consider Unsafe.

MAINTENANCE INSTRUCTIONS

Important: To keep tool safe, a Preventative Maintenance Program is recommended. The program should include inspection of the tool and all related accessories and consumables, including air lines, pressure regulators, filters, oilers, etc. (refer to CAGI B186.1 for additional maintenance information). If accessory or tool breakage occurs, investigate failure to determine the cause and correct before issuing tool for work. Use the following schedule as a starting point in developing a Preventative Maintenance Program. If tool does not operate properly (RPM, vibration, start/stop) after these scheduled checks or at any time, the tool must be repaired and corrected before returning tool to use.



INSTALLATION

- To ensure long life and dependable service, use a Closed Loop Air System and Filter-Regulator-Lubricator (FRL) as diagramed below.
- Each tool should have its own dedicated hose connected to an air supply FRL. Quick disconnects should be installed at the FRL in an effort to reduce contamination into the tool. Securely affix all fittings and hose assemblies.
- It is strongly recommended that all Dynabrade rotary vane air tools be used with a Filter-Regulator-Lubricator to minimize the possibility of misuse due to unclean air, wet air or insufficient lubrication. Dynabrade recommends the following: **10690** Air Line Filter-Regulator-Lubricator — Provides accurate air pressure regulation, two-stage filtration of water contaminants and micro-mist lubrication of pneumatic components.
- Dynabrade recommends 1 drop of air lube per minute for each 20 SCFM (example: if the tool specification states 40 SCFM, set the drip rate on the filter-lubricator to 2 drops per minute). **95842** Dynabrade Air Lube is recommended.

MAINTENANCE SCHEDULE

Maintenance schedules depend on the type and style of tool. Refer to page 3 to reference symbols associated with specific maintenance items/areas. Match maintenance schedules accordingly. See page 4 for any additional maintenance information.

Daily (every 8 hours):

- Inspect tool and accessories for damage or broken parts. Replace items as necessary to ensure proper operation and safety.
-  Lubricate motor as recommended. Use **95842** Dynabrade Air Lube (10W/NR). Apply 1 drop/minute of air lube per 20 SCFM.
- Check air line pressure with a gage. (MAX. 90 PSIG or 6.2 Bar operating pressure at the air inlet of the tool.)
-  Lubricate right angle gears through gear case fitting. Apply 3 plunges of **95848** Gear Oil. Use **95541** Lubricant Gun (Prime lubricant gun before use).
- Check tool for proper operation: If operating improperly or demonstrates unusual vibration, the tool must be serviced and problem corrected before further use.

Every 20 Hours/Once a Week (which ever comes first):

- Measure RPM (speed) by setting air pressure to 90 PSIG (6.2 Bar) at tool inlet, without accessory mounted, while the tool is running. Using tachometer, check spindle speed of the tool. A non-governed tool may exceed the RPM marked on the tool by 10% when operated at free speed with no accessories.

- If tool is running too fast: look for worn, damaged or missing governor, air control rings and silencer(s). Service as required.
- If tool is running too slow: look for malfunctioning governor, clogged inlet screen, silencer(s) or air stream. Service as required.

Note: Special care must be taken when servicing governors. Refer to specific tool manual for governor instructions and/or speed control devices. Governor assemblies made from molded plastic components are non-serviceable and must be replaced.

Every 50 Hours:

-  Lubricate planetary gears through gear case fitting with 3 plunges of **95544** Grease. Use **95541** Lubricant Gun. (Prime lubricant gun before use).

REPAIR

- Use only genuine Dynabrade replacement parts to ensure quality. To order replacement parts, specify Model#, Serial# and RPM of your air tool.
- Mineral spirits are recommended when cleaning the tool and parts. Do not clean tool or parts with any solvents or oils containing acids, esters, ketones, chlorinated hydrocarbons or nitro carbons.
- Air tool markings must be kept legible at all times, if not, reorder housing and replace. User is responsible for maintaining specification information.

-  After maintenance is performed on tool, add a few drops of **95842** Dynabrade Air Lube to the tool inlet and start the tool a few times to lubricate air motor. Verify RPM (per 20 hr maintenance schedule), vibration and operation.

HANDLING & STORAGE

- Use of tool rests, hangers and/or balancers is recommended.
- Protect tool inlet from debris (see Notice below).
- **Do Not** carry tool by air hose or near the tool throttle lever.
- Store accessories in protective racks or compartments to prevent damage.
- Follow the handling instructions outlined in the operating instructions when carrying the tool and when changing accessories.
- Protect accessories from exposure to water, solvents, high humidity, freezing temperature and extreme temperature changes.

END OF USE/DISPOSAL

When tool has reached its end of useful service, disassemble tool into its primary components (i.e. steel, aluminum and plastic) and recycle or discard per local, state and/or federal regulations as to not harm the environment.

NOTICE

All Dynabrade air motors use the highest quality parts available and are manufactured to exacting tolerances. Air motor failures are often traced to lack of lubrication or unclean air supply. Compressed air can force dirt and other contaminants into motor bearings causing early failure. Contaminants can score cylinder wall and vanes resulting in reduced efficiency and power. Our warranty obligation is contingent upon proper use of our tools. Air motors which have been subjected to misuse, contaminated air or lack of lubrication will void warranty.

CLOSED LOOP AIR SYSTEM

Sloped in Direction of Air Flow

- Dynabrade Air Power Tools are designed to operate at 90 PSIG (6.2 Bar) maximum air pressure at the tool inlet, when the tool is running. Use recommended regulator to control air pressure.
- Ideally the air supply should be free from moisture. To facilitate removing moisture from air supply, the installation of a refrigerated air dryer after the compressor and the use of drain valves at each tool station is recommended.

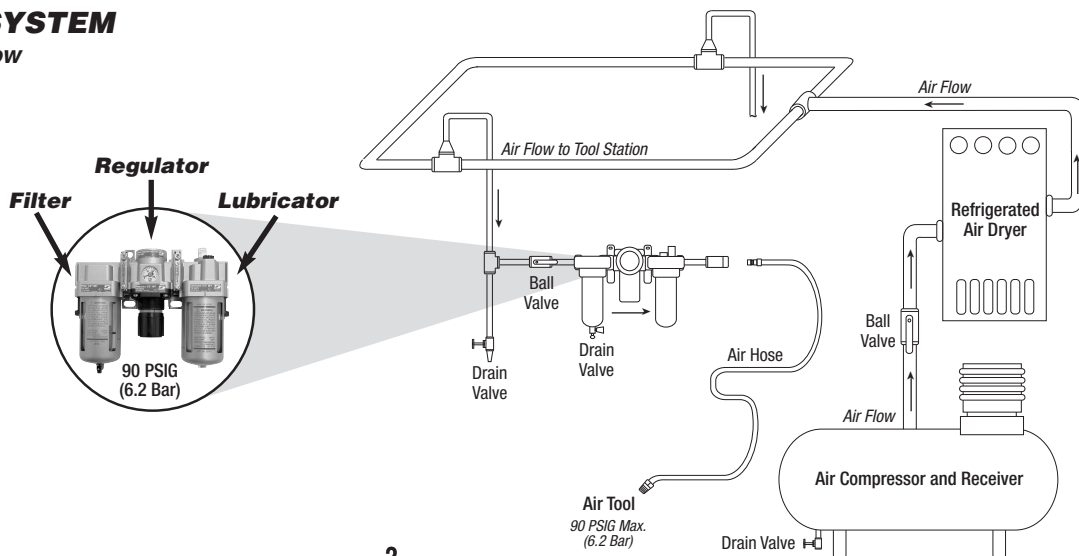

Lubricator Setting

1 Drop/Minute per 20 SCFM

Dynabrade Nitro Series™ 2" Right Angle Disc Sander Complete Assembly

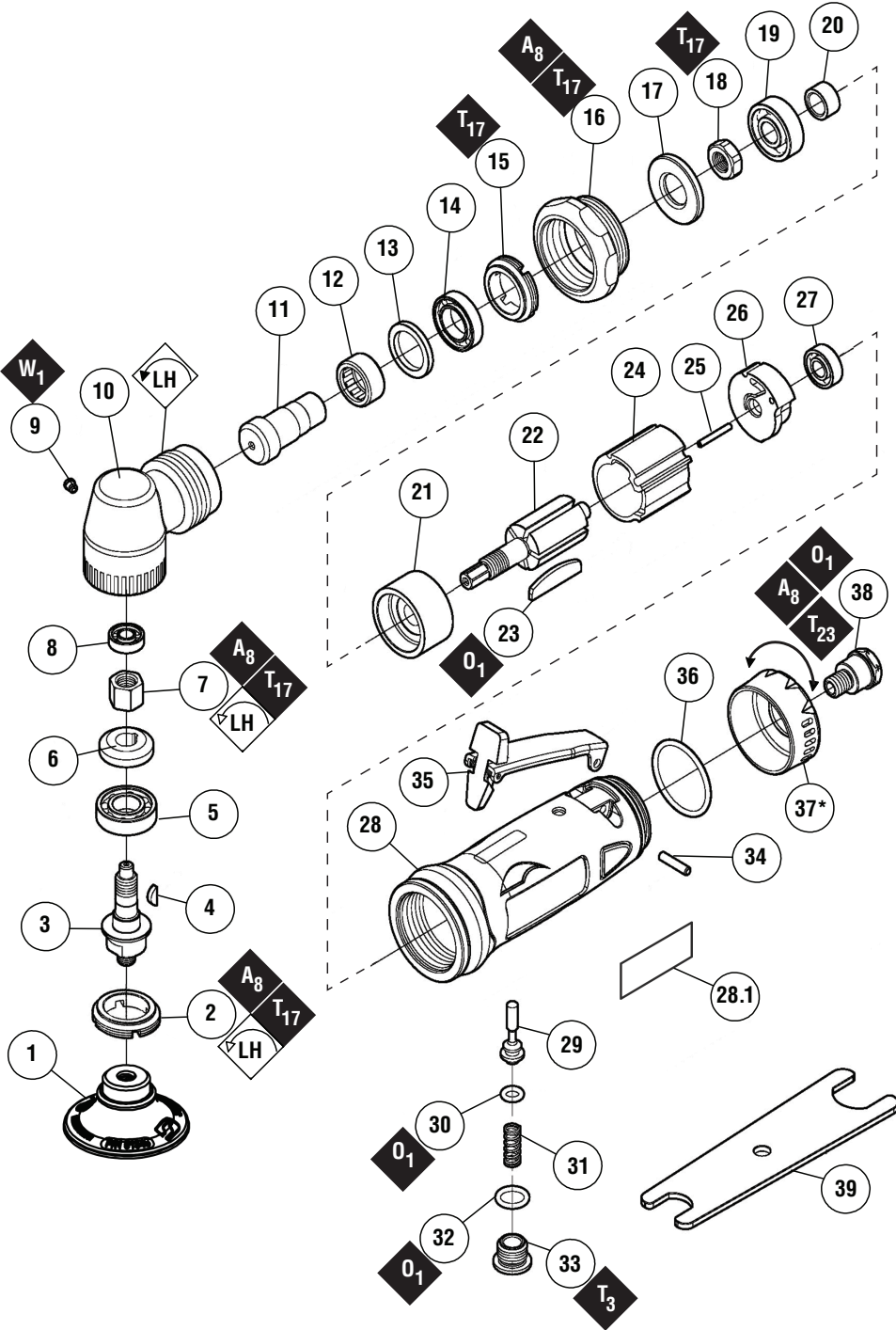

ITEM	P/N	DESCRIPTION	QTY.
1	51348	PAD - 2"	1
2	55940	LOCK NUT	1
3	55987	SPINDLE - 1/4-20	1
4	55942	KEY	1
5	55943	BEARING	1
6	55944	GEAR	1
7	55945	SPINDLE NUT	1
8	55946	BEARING	1
9	55947	GREASE FITTING	1
10	55948	RIGHT ANGLE HOUSING	1
11	55949	PINION	1
12	55950	NEEDLE BEARING	1
13	55951	SPACER	1
14	55952	BEARING	1
15	55953	LOCK NUT	1
16	55954	LOCK RING	1
17	55955	WASHER	1
18	55956	NUT	1
19	55914	BEARING	1
20	55957	ROTOR SPACER	1
21	55958	FRONT END PLATE	1
22	55959	ROTOR	1
23	55918	VANE	5
24	55919	CYLINDER	1
25	55920	PIN	1
26	55921	REAR END PLATE	1
27	55922	BEARING	1
28	55988	HOUSING ASSY. - MDL# DS32	1
28.1	55924	LABEL	1
29	55925	VALVE STEM	1
30	55926	O-RING	1
31	55927	VALVE SPRING	1
32	55928	O-RING	1
33	55929	VALVE CAP	1
34	55930	PIN	1
35	55931	LEVER ASSY.	1
36	55932	O-RING	1
37*	55933	EXHAUST COVER	1
38	55934	INLET BUSHING	1
39	55961	WRENCH	1

KEY

- O** Oil: O₁ = Air Lube
- A** Adhesive: A₈ = Loctite #567
- T_x** X = Torque Value (N•m)
(N•m x 8.85 = lb•in.)
- W₁** Gear Oil: W₁ = 95848

Always follow adhesive manufacturers cleaning and priming recommendations.

CAUTION

*Exhaust cover swivels 360°. Direct exhaust air away from operator, and in a direction that does not cause additional hazards.

ONE YEAR WARRANTY

To validate Dynabrade One Year Warranty, you must register each tool at: www.dynabrade.com. Registration of each tool at website is required. Dynabrade will not honor One Year Warranty on unregistered tools. Please view the entire One Year Warranty Policy at www.dynabrade.com.

MACHINE SPECIFICATIONS

Model	Speed	Power	Air Consumption	Tool Thread	Weight	Length	Height
DS32	18,000 RPM	.3 hp (224 W)	18 SCFM (510 LPM)	1/4" – 20	1.1 lb. (.5 kg)	6.8" (174 mm)	2.5" (63 mm)

Additional Specifications: Air Inlet Thread 1/4" NPT • Hose I.D. 1/4" (6 mm)
Visit dynabrade.com for your model's current vibration and sound data.

OPTIONAL ACCESSORIES



Dynabrade Air Lube

- Formulated for pneumatic equipment.
- Absorbs up to 10% of its weight in water.
- Prevents rust and formation of sludge.
- Keeps pneumatic tools operating longer with greater power and less down time.

Part No. 95842: 1 pt. (473 ml)

Part No. 95843: 1 gal. (3.8 L)



Dynabrade Gear Oil

- Specifically formulated to saturate wick system to right angle gear head.
- Apply every 8 hours of operation into tool's lubrication fitting.

Part No. 95848: 2.5 oz. (74 ml) tube

Part No. 95541: Push-type grease gun

REFERENCE CONTACT INFORMATION

American National Standards Institute (ANSI)

www.ansi.org

Compressed Air & Gas Institute (CAGI)

www.cagi.org

European Committee for Standardization (PNEUROPE)

www.pneurop.org

International Organization of Standards (ISO)

www.iso.org

U.S. Government Publishing Office (GPO)

www.gpo.gov

DYNABRADE, INC.

www.dynabrade.com

8989 Sheridan Drive • Clarence, NY 14031-1419 • Phone: (716) 631-0100 • Fax: 716-631-2073 • International Fax: 716-631-2524
©DYNABRADE, INC., 2018

